

MODEL CP1 CHEM PRUF STANDARD DOOR

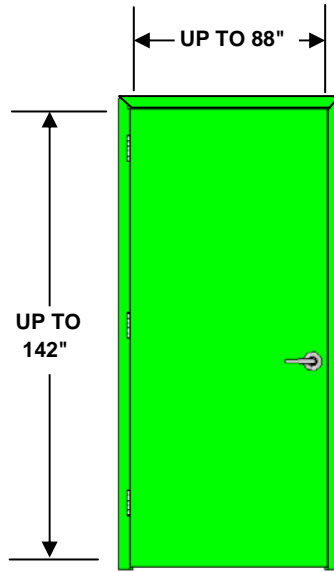

FOR LARGER SIZES CONTACT CHEM-PRUF REPRESENTATIVE

MORE THAN 20 BEAUTIFUL TEXTURE AND DOOR PANEL DESIGNS AVAILABLE SEE CHEM PRUF MOLD BROCHURE HERE

MAXIMUM DOOR SIZE : 88" X 142"

CERTIFICATION : ATMOSPHERIC PATENTED DOOR / IMPACT ASTM E 1886 / 1996 DOOR SKIN BY ITSELF

FRAME STYLES AVAILABLE

STYLE	WIDTH
1	3-1/2" TO 5-3/4"
2	3-1/2" TO 5-3/4"
4 optional 4" HDR	5-3/4"
4.4 optional 4" HDR	4"
11 optional 4" HDR	VARIABLE UP TO 9"

CORE MATERIALS AVAILABLE

	THERMAL R	SOUND STC
FOAM	11	33
PPC	3	33
MINERAL CORE	2	35
BALSA	2	33

WINDOW STYLES

WXL	STD	PHARMACEUTICAL

HARDWARE * *FACTORY INSTALLED - CERTIFIED CRAFTSMEN

Entry Devices	Closers	Hinges	Transoms/Panels
Unlimited	Unlimited	Unlimited	Unlimited
Special Request	Louwer	Window	Accessories
Available	Up to full louwer	Up to full window	Unlimited

APPLICABLE STANDARDS

AAMA 920-03 CYCLE PERFORMANCE
 ASTM C518 HEAT TRANSFER PROPERTIES
 ASTM D 1929 SELF IGNITION
 ASTM D 2843 SMOKE DENSITY
 ASTM D 790 FLEXURAL PROPERTIES
 ASTM E 1332 SOUND TRANSMISSION
 ASTM E 2235 SOUND INSULATIONS
 ASTM E 90 SOUND LOSS
 SFBC 3603.2 FORCED ENTRY TEST

ANSI A250.4 ENDURANCE OF DOORS
 ASTM D 1622 DENSITY & SPECIFIC GRAVITY
 ASTM D 256 IZOD IMPACT RESISTANCE
 ASTM D 635 RATE OF BURNING
 ASTM D 792 DENSITY OF PLASTICS
 ASTM E 1886 IMPACT PERFORMANCE
 ASTM E 413 RATING OF SOUND INSULATION
 ASTM G 155 LIGHT EXPOSURE

ASTM C 177 THERMAL PROPERTIES
 ASTM D 1761 PROPERTIES OF FASTENERS
 ASTM D 2583 HARDNESS OF MATERIALS
 ASTM D 638 PLASTICS TENSILE STRENGTH
 ASTM D 882 TENSILE PROPERTIES
 ASTM E 1996 IMPACT OF SYSTEMS
 ASTM E 84 BURNING CHARACTERISTICS
 NWWEA TM-7 ENDURANCE OF DOORS

NOTE : ALL TESTS AND CERTIFICATIONS PERFORMED BY INDEPENDENT ACCREDITED LABORATORIES. CONTACT Chem-Pruf® FOR DETAILED MODEL/SERIES VALUES OR GO ONLINE AT WWW.CHEM-PRUF.COM. TESTS RESULTS SHALL BE MADE AVAILABLE UPON REQUEST FOR EACH MODEL LISTED ABOVE. COPYRIGHT CHEM-PRUF DOOR CO. LT. 2010

**** FRAME STYLES & PROFILES**

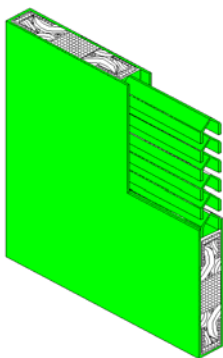
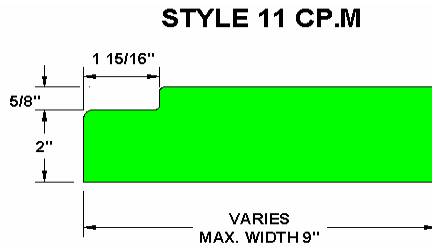
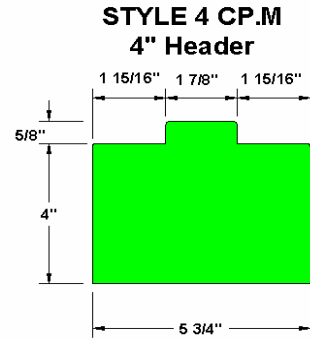
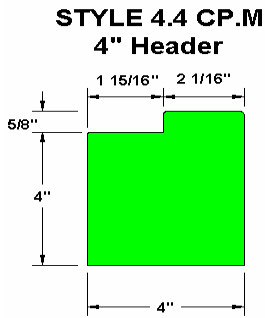
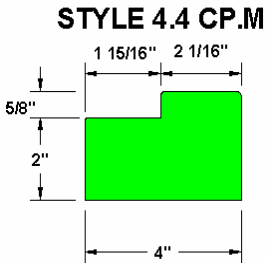
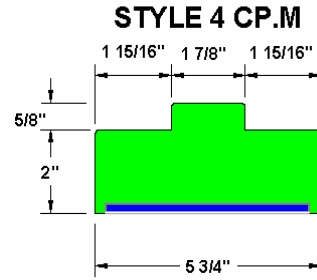
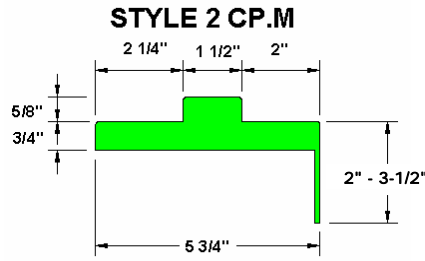
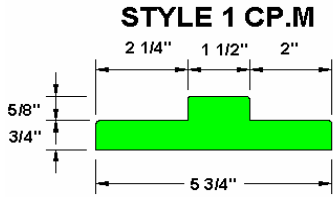

LOUVER

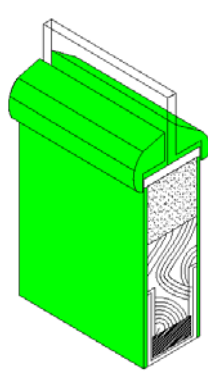

**WXL
WINDOW**

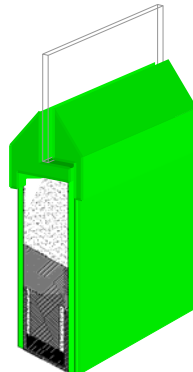

**SLIM LINE
WINDOW**

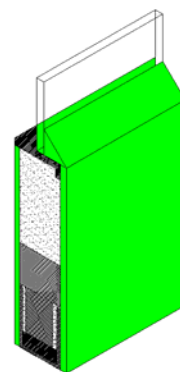

**PHARMACEUTICAL
WINDOW**

NOTE : ALL TESTS AND CERTIFICATIONS PERFORMED BY INDEPENDENT ACCREDITED LABORATORIES. CONTACT Chem-Pruf® FOR DETAILED MODEL/SERIES VALUES OR GO ONLINE AT WWW.CHEM-PRUF.COM. TESTS RESULTS SHALL BE MADE AVAILABLE UPON REQUEST FOR EACH MODEL LISTED ABOVE. COPYRIGHT CHEM-PRUF DOOR CO. LT. 2010

MODEL CP2 CHEM PRUF UL 10(b) & UL 10(c) FIRE RATED CERTIFIED DOUBLE DOOR

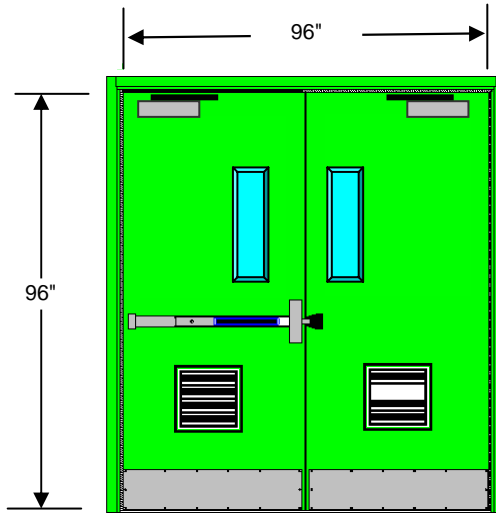

MAXIMUM DOOR LEAF SIZE : 48" X 96"

CERTIFICATION : UL 10(b) UL 10(c)

FRAME STYLES AVAILABLE

CORE MATERIALS AVAILABLE

STYLE	WIDTH	MINERAL CORE	THERMAL R	SOUND STC
			2	35
1	3-1/2" TO 5-3/4"			
2	3-1/2" TO 5-3/4"			
4 optional 4" HDR	5-3/4"			
4.4 optional 4" HDR	4"			
11 optional 4" HDR	VARIABLE UP TO 9"			

VISION LITES

20MIN	Max 1296 square inch vision
45MIN	Max 1296 square inch vision
60MIN	Max 100 square inch vision
90MIN	Max 100 square inch vision

HARDWARE *

*FACTORY INSTALLED CERTIFIED CRAFTSMEN

ALL HARDWARE MUST BE FIRE RATED

Entry Devices

Mortise Type
Cylindrical Type
Rim Panic
Mortise Panic
Surface Vertical Rod

Closers

Surface mounted
Overhead Stops

Louwer *

176 sq-in

Flush Bolt

Only on 10 (b)

Hinges *

Unlimited

Astragal *

Stainless Steel

Window *

See lite sizes table

Special Request

Electrical Raceway
Electrical Power Transfer

* Stainless Steel Recommended

APPLICABLE STANDARDS

UL 10C FIRE TESTS OF DOOR ASSEMBLIES

UL 10B FIRE TESTS OF DOOR ASSEMBLIES

NFPA 252 FIRE TESTS OF DOORS

NFPA 80 FIRE TESTS OF DOORS

ASTM E 2074 FIRE TEST OF DOORS

ASTM E 152 FIRE TESTS OF DOOR ASSEMBLIES

ASTM G 155 LIGHT EXPOSURE

ASTM E 84 BURNING CHARACTERISTICS

ASTM E 1332 SOUND TRANSMISSION

ASTM C 177 THERMAL PROPERTIES

ASTM C 518 HEAT TRANSFER PROPERTIES

ASTM D 1622 DENSITY & SPECIFIC GRAVITY

ASTM D 1761 PROPERTIES OF FASTENERS

ASTM D 1929 SELF IGNITION

ASTM D 256 IZOD IMPACT RESISTANCE

ASTM D 2583 HARDNESS OF MATERIALS

ASTM D 2843 SMOKE DENSITY

ASTM D 635 RATE OF BURNING

ASTM D 638 PLASTICS TENSILE STRENGTH

ASTM D 790 FLEXURAL PROPERTIES

ASTM D 792 DENSITY OF PLASTICS

ASTM D 882 TENSILE PROPERTIES

ASTM E 90 SOUND LOSS

ASTM E 2235 SOUND INSULATIONS

ASTM E 413 RATING OF SOUND INSULATION

NOTE : ALL TESTS AND CERTIFICATIONS PERFORMED BY INDEPENDENT ACCREDITED LABORATORIES. CONTACT Chem-Pruf® FOR DETAILED MODEL/SERIES VALUES OR GO ONLINE AT WWW.CHEM-PRUF.COM. TESTS RESULTS SHALL BE MADE AVAILABLE UPON REQUEST FOR EACH MODEL LISTED ABOVE. COPYRIGHT CHEM-PRUF DOOR CO. LT. 2010

MODEL CP2 CHEM PRUF UL 10(b) & UL 10(c) FIRE RATED CERTIFIED DOUBLE DOOR

**** FRAME STYLES & PROFILES**

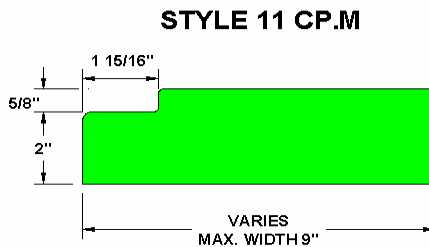
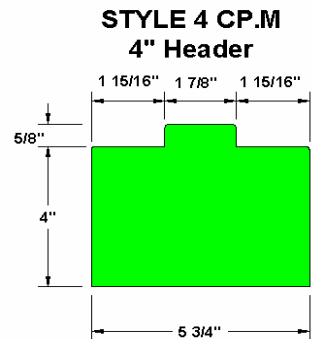
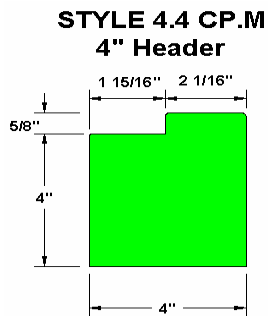
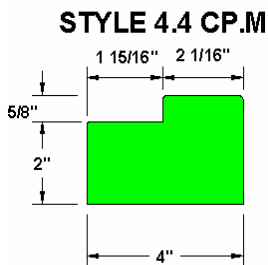
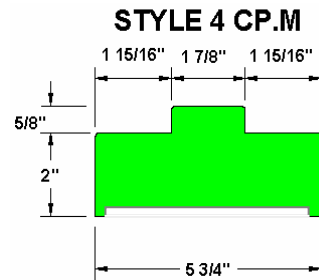
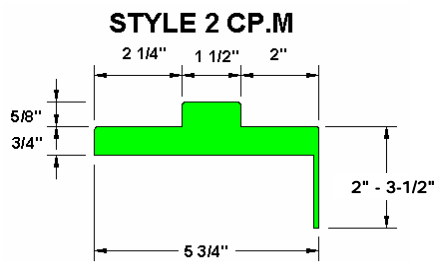
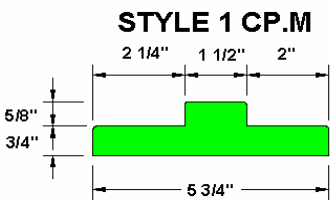

NOTE : ALL TESTS AND CERTIFICATIONS PERFORMED BY INDEPENDENT ACCREDITED LABORATORIES. CONTACT Chem-Pruf® FOR DETAILED MODEL/SERIES VALUES OR GO ONLINE AT WWW.CHEM-PRUF.COM. TESTS RESULTS SHALL BE MADE AVAILABLE UPON REQUEST FOR EACH MODEL LISTED ABOVE. COPYRIGHT CHEM-PRUF DOOR CO. LT. 2010

MODEL CP3 CHEM PRUF UL 10(b) & UL 10(c) FIRE RATED CERTIFIED SINGLE DOOR

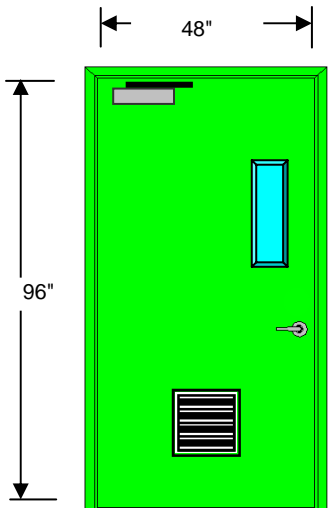

MAXIMUM DOOR LEAF SIZE : 48" X 96"

CERTIFICATION : UL 10(b) UL 10(c)

FRAME STYLES AVAILABLE		CORE MATERIALS AVAILABLE		
STYLE	WIDTH	MINERAL CORE	THERMAL R	SOUND STC
1	3-1/2" TO 5-3/4"		2	35
		VISION LITES		
2	3-1/2" TO 5-3/4"	20MIN	Max 1296 square inch vision	
4 optional 4" HDR	5-3/4"	45MIN	Max 1296 square inch vision	
4.4 optional 4" HDR	4"	60MIN	Max 100 square inch vision	
11 optional 4" HDR	VARIABLE UP TO 9"	90MIN	Max 100 square inch vision	

HARDWARE * *FACTORY CERTIFIED CRAFTSMEN ALL HARDWARE MUST BE FIRE RATED

<p>Entry Devices</p> <p>Mortise Type</p> <p>Cylindrical Type</p> <p>Rim Panic</p> <p>Mortise Panic</p> <p>Surface Vertical Rod</p>	<p>Closers</p> <p>Surface mounted</p> <p>Overhead Stops</p> <p>Louver *</p> <p>176 sq-in</p> <p>Flush Bolt</p> <p>Only on 10 (b)</p>	<p>Hinges *</p> <p>Unlimited</p> <p>Astragal *</p> <p>Stainless Steel</p>	<p>Window *</p> <p>See lite sizes table</p> <p>Special Request</p> <p>Electrical Raceway</p> <p>Electrical Power Transfer</p>
---	---	---	---

* Stainless Steel Recommended

APPLICABLE STANDARDS

<p>UL 10C FIRE TESTS OF DOOR ASSEMBLIES</p> <p>UL 10B FIRE TESTS OF DOOR ASSEMBLIES</p> <p>NFPA 252 FIRE TESTS OF DOORS</p> <p>NFPA 80 FIRE TESTS OF DOORS</p> <p>ASTM E 2074 FIRE TEST OF DOORS</p> <p>ASTM E 152 FIRE TESTS OF DOOR ASSEMBLIES</p> <p>ASTM G 155 LIGHT EXPOSURE</p> <p>ASTM E 84 BURNING CHARACTERISTICS</p> <p>ASTM E 1332 SOUND TRANSMISSION</p>	<p>ASTM C 177 THERMAL PROPERTIES</p> <p>ASTM C 518 HEAT TRANSFER PROPERTIES</p> <p>ASTM D 1622 DENSITY & SPECIFIC GRAVITY</p> <p>ASTM D 1761 PROPERTIES OF FASTENERS</p> <p>ASTM D 1929 SELF IGNITION</p> <p>ASTM D 256 IZOD IMPACT RESISTANCE</p> <p>ASTM D 2583 HARDNESS OF MATERIALS</p> <p>ASTM D 2843 SMOKE DENSITY</p> <p>ASTM D 635 RATE OF BURNING</p>	<p>ASTM D 638 PLASTICS TENSILE STRENGTH</p> <p>ASTM D 790 FLEXURAL PROPERTIES</p> <p>ASTM D 792 DENSITY OF PLASTICS</p> <p>ASTM D 882 TENSILE PROPERTIES</p> <p>ASTM E 90 SOUND LOSS</p> <p>ASTM E 2235 SOUND INSULATIONS</p> <p>ASTM E 413 RATING OF SOUND INSULATION</p>
---	---	---

NOTE : ALL TESTS AND CERTIFICATIONS PERFORMED BY INDEPENDENT ACCREDITED LABORATORIES. CONTACT Chem-Pruf® FOR DETAILED MODEL/SERIES VALUES OR GO ONLINE AT WWW.CHEM-PRUF.COM. TESTS RESULTS SHALL BE MADE AVAILABLE UPON REQUEST FOR EACH MODEL LISTED ABOVE. COPYRIGHT CHEM-PRUF DOOR CO. LT. 2010

MODEL CP3 CHEM PRUF UL 10(b) & UL 10(c) FIRE RATED CERTIFIED SINGLE DOOR

**** FRAME STYLES & PROFILES**

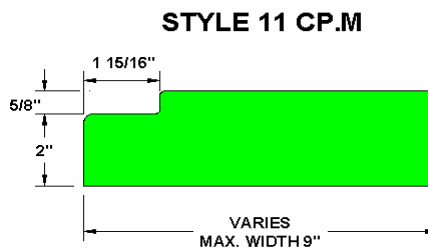
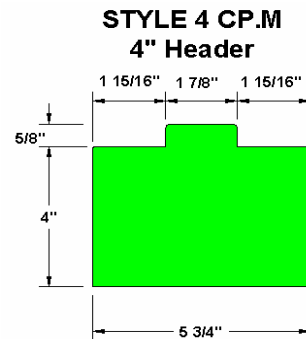
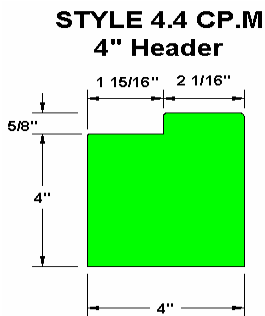
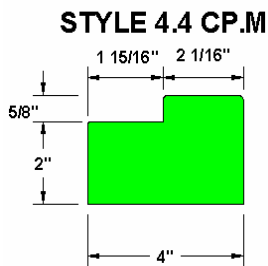
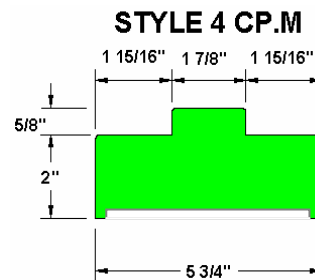
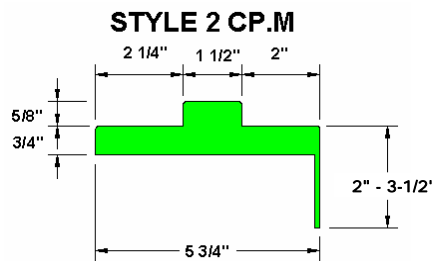
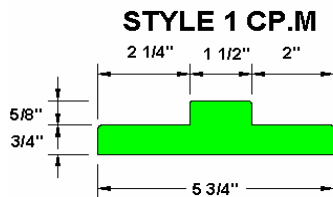

NOTE : ALL TESTS AND CERTIFICATIONS PERFORMED BY INDEPENDENT ACCREDITED LABORATORIES. CONTACT Chem-Pruf® FOR DETAILED MODEL/SERIES VALUES OR GO ONLINE AT WWW.CHEM-PRUF.COM. TESTS RESULTS SHALL BE MADE AVAILABLE UPON REQUEST FOR EACH MODEL LISTED ABOVE. COPYRIGHT CHEM-PRUF DOOR CO. LT. 2010

MODEL CP4 CHEM PRUF BLAST DOOR

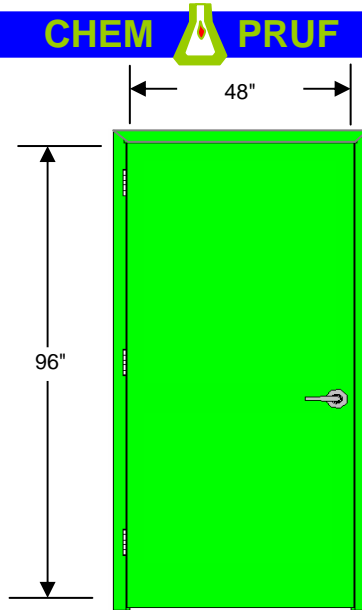

MAXIMUM DOOR SIZE: 48" X 96"

CERTIFICATION : BLAST DOOR 150 psf

FRAME STYLES AVAILABLE

CORE MATERIALS AVAILABLE

STYLE	WIDTH		THERMAL R	SOUND STC
4	5-3/4"	FOAM (8LB)	11	33
		PPC	3	33

HARDWARE

MUST BE BLAST RATED - FACTORY INSTALLED CERTIFIED CRAFTSMEN

Entry Devices

Blast Rated

Closers

Consult CP Rep

Hinges

(4) 4-1/2"

Window

No

Louwer

No

Accessories

Consult CP Rep

APPLICABLE STANDARDS

AAMA 920-03 CYCLE PERFORMANCE
 ASTM C518 HEAT TRANSFER PROPERTIES
 ASTM D 1929 SELF IGNITION
 ASTM D 2843 SMOKE DENSITY
 ASTM D 790 FLEXURAL PROPERTIES
 ASTM E 1332 SOUND TRANSMISSION
 ASTM E 2235 SOUND INSULATIONS
 ASTM E 84 BURNING CHARACTERISTICS
 NWWEA TM-7 ENDURANCE OF DOORS

ANSI A250.4 ENDURANCE OF DOORS
 ASTM D 1622 DENSITY & SPECIFIC GRAVITY
 ASTM D 256 IZOD IMPACT RESISTANCE
 ASTM D 635 RATE OF BURNING
 ASTM D 792 DENSITY OF PLASTICS
 ASTM E 1886 IMPACT PERFORMANCE
 ASTM E 330 STRUCTURAL TESTS OF DOORS
 ASTM E 90 SOUND LOSS
 SFBC 3603.2 FORCED ENTRY TEST

ASTM C 177 THERMAL PROPERTIES
 ASTM D 1761 PROPERTIES OF FASTENERS
 ASTM D 2583 HARDNESS OF MATERIALS
 ASTM D 638 PLASTICS TENSILE STRENGTH
 ASTM D 882 TENSILE PROPERTIES
 ASTM E 1996 IMPACT OF SYSTEMS
 ASTM E 413 RATING OF SOUND INSULATION
 ASTM G 155 LIGHT EXPOSURE

NOTE : ALL TESTS AND CERTIFICATIONS PERFORMED BY INDEPENDENT ACCREDITED LABORATORIES. CONTACT Chem-Pruf® FOR DETAILED MODEL/SERIES VALUES OR GO ONLINE AT WWW.CHEM-PRUF.COM. TESTS RESULTS SHALL BE MADE AVAILABLE UPON REQUEST FOR EACH MODEL LISTED ABOVE. COPYRIGHT CHEM-PRUF DOOR CO. LT. 2010

**** FRAME STYLES & PROFILES**

STYLE 4 CP.M

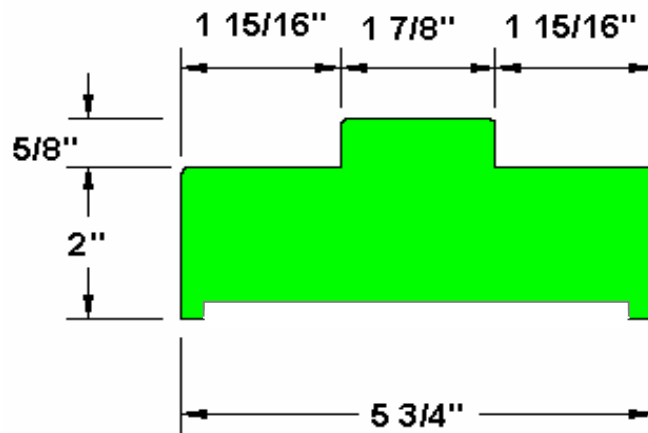

NOTE : ALL TESTS AND CERTIFICATIONS PERFORMED BY INDEPENDENT ACCREDITED LABORATORIES. CONTACT Chem-Pruf® FOR DETAILED MODEL/SERIES VALUES OR GO ONLINE AT WWW.CHEM-PRUF.COM. TESTS RESULTS SHALL BE MADE AVAILABLE UPON REQUEST FOR EACH MODEL LISTED ABOVE. COPYRIGHT CHEM-PRUF DOOR CO. LT. 2010

MODEL CP5 CHEM PRUF BALLISTIC DOOR

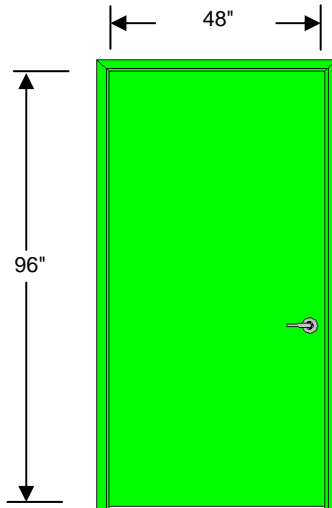

MAXIMUM DOOR SIZE : 48" x 96"

CERTIFICATION : UL 752 AT ALL EIGHT LEVELS

FRAME STYLES AVAILABLE		CORE MATERIALS AVAILABLE		
STYLE	WIDTH		THERMAL R	SOUND STC
1	3-1/2" TO 5-3/4"	BALLISTIC PLATE (door and frame)	2	42
2	3-1/2" TO 5-3/4"			
4 optional 4" HDR	5-3/4"			
4.4 optional 4" HDR	4"			
11 optional 4" HDR	VARIABLE UP TO 9"			

HARDWARE* *FACTORY INSTALLED CERTIFIED CRAFTSMEN

Entry Devices

Unlimited

Closers

Unlimited

Accessories

Unlimited

Window

NO

Hinges

(6) 5" X 6"

Special Request

Consult CP Representative

APPLICABLE STANDARDS

UL 752 BULLET RESISTANCE
ASTM C518 HEAT TRANSFER PROPERTIES
ASTM D 1929 SELF IGNITION
ASTM D 2843 SMOKE DENSITY
ASTM D 790 FLEXURAL PROPERTIES
ASTM E 1332 SOUND TRANSMISSION
ASTM E 2235 SOUND INSULATIONS
ASTM E 90 SOUND LOSS

ASTM D 1622 DENSITY & SPECIFIC GRAVITY
ASTM D 256 IZOD IMPACT RESISTANCE
ASTM D 635 RATE OF BURNING
ASTM D 792 DENSITY OF PLASTICS
ASTM E 1886 IMPACT PERFORMANCE
ASTM E 413 RATING OF SOUND INSULATION
ASTM G 155 LIGHT EXPOSURE

ASTM C 177 THERMAL PROPERTIES
ASTM D 1761 PROPERTIES OF FASTENERS
ASTM D 2583 HARDNESS OF MATERIALS
ASTM D 638 PLASTICS TENSILE STRENGTH
ASTM D 882 TENSILE PROPERTIES
ASTM E 1996 IMPACT OF SYSTEMS
ASTM E 84 BURNING CHARACTERISTICS

NOTE : ALL TESTS AND CERTIFICATIONS PERFORMED BY INDEPENDENT ACCREDITED LABORATORIES. CONTACT Chem-Pruf® FOR DETAILED MODEL/SERIES VALUES OR GO ONLINE AT WWW.CHEM-PRUF.COM. TESTS RESULTS SHALL BE MADE AVAILABLE UPON REQUEST FOR EACH MODEL LISTED ABOVE. COPYRIGHT CHEM-PRUF DOOR CO. LT. 2010

MODEL CP5 CHEM PRUF BALLISTIC DOOR

** FRAME STYLES & PROFILES

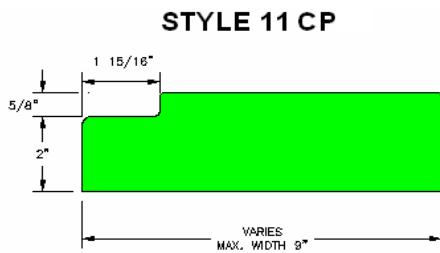
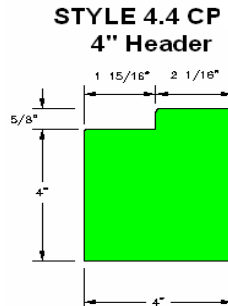
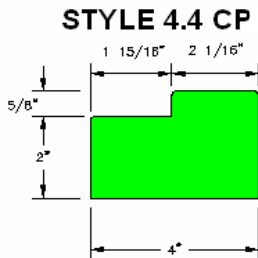
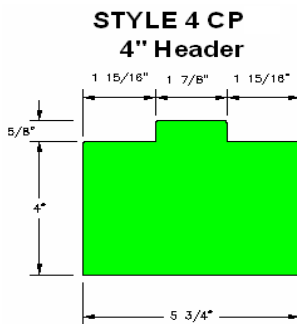
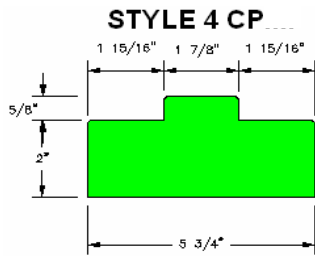
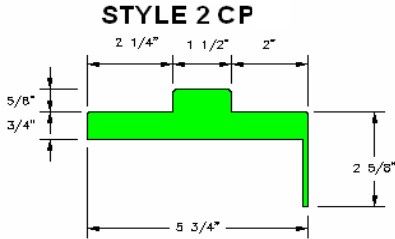
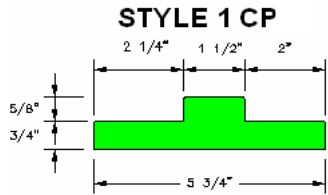

UL Listed at ALL 8 Levels

1	3 Shots	9mm
2	3 shots	.357 Magnum
3	3 shots	.44 Magnum
4	1 Shot	.30 Caliber Rifle
5	1 Shot	7.62mm Rifle
6	5 Shots	9mm
7	5 Shots	5.56mm Rifle
8	5 Shots	7.62mm Rifle

NOTE : ALL TESTS AND CERTIFICATIONS PERFORMED BY INDEPENDENT ACCREDITED LABORATORIES. CONTACT Chem-Pruf® FOR DETAILED MODEL/SERIES VALUES OR GO ONLINE AT WWW.CHEM-PRUF.COM. TESTS RESULTS SHALL BE MADE AVAILABLE UPON REQUEST FOR EACH MODEL LISTED ABOVE. COPYRIGHT CHEM-PRUF DOOR CO. LT. 2010

MODEL CP6 CHEM PRUF FDA-USDA DOOR

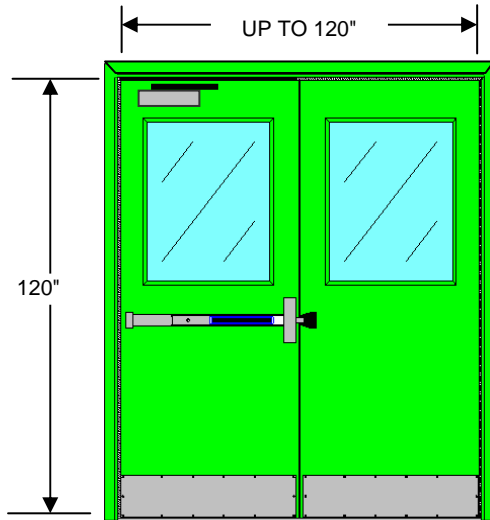

MAXIMUM DOOR LEAF SIZE : 58" X 118"

CERTIFICATION : FDA USDA

FRAME STYLES AVAILABLE		CORE MATERIALS AVAILABLE		
STYLE	WIDTH		THERMAL R	SOUND STC
1	3-1/2" TO 5-3/4"	FOAM	11	33
2	3-1/2" TO 5-3/4"	PPC (standard)	3	33
4 optional 4" HDR	5-3/4"	MINERAL CORE	2	35
4.4 optional 4" HDR	4"	BALSA	2	33
11 optional 4" HDR	VARIABLE UP TO 9"			

GELCOAT COLOR : FDA WHITE

HARDWARE* *FACTORY INSTALLED CERTIFIED CRAFTSMEN

Entry devices	Closers	Special Request	Hinges
Unlimited	Unlimited	Available	Unlimited
Window	Louwer	Accessories	
Up to full glass	Up to full louwer	Unlimited	

APPLICABLE STANDARDS

AAMA 920-03 CYCLE PERFORMANCE	ANSI A250.4 ENDURANCE OF DOORS	ASTM C 177 THERMAL PROPERTIES
ASTM C518 HEAT TRANSFER PROPERTIES	ASTM D 1622 DENSITY & SPECIFIC GRAVITY	ASTM D 1761 PROPERTIES OF FASTENERS
ASTM D 1929 SELF IGNITION	ASTM D 256 IZOD IMPACT RESISTANCE	ASTM D 2583 HARDNESS OF MATERIALS
ASTM D 2843 SMOKE DENSITY	ASTM D 635 RATE OF BURNING	ASTM D 638 PLASTICS TENSILE STRENGTH
ASTM D 790 FLEXURAL PROPERTIES	ASTM D 792 DENSITY OF PLASTICS	ASTM D 882 TENSILE PROPERTIES
SFBC 3603.2 FORCED ENTRY TEST	ASTM E 1886 IMPACT PERFORMANCE	ASTM E 1996 IMPACT OF SYSTEMS
ASTM E 84 BURNING CHARACTERISTICS	ASTM G 155 LIGHT EXPOSURE	NWWEA TM-7 ENDURANCE OF DOORS

NOTE : ALL TESTS AND CERTIFICATIONS PERFORMED BY INDEPENDENT ACCREDITED LABORATORIES. CONTACT Chem-Pruf® FOR DETAILED MODEL/SERIES VALUES OR GO ONLINE AT WWW.CHEM-PRUF.COM. TESTS RESULTS SHALL BE MADE AVAILABLE UPON REQUEST FOR EACH MODEL LISTED ABOVE. COPYRIGHT CHEM-PRUF DOOR CO. LT. 2010

MODEL CP6 CHEM PRUF FDA-USDA DOOR

** FRAME STYLES & WINDOW PROFILES

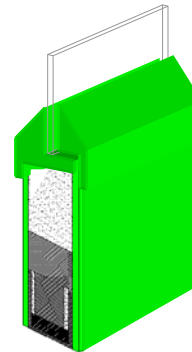
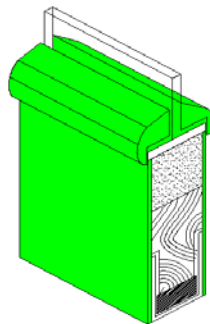
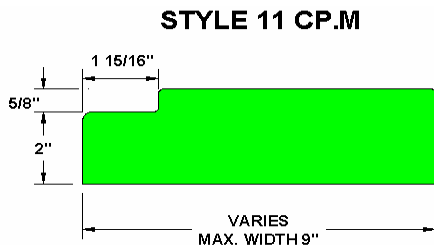
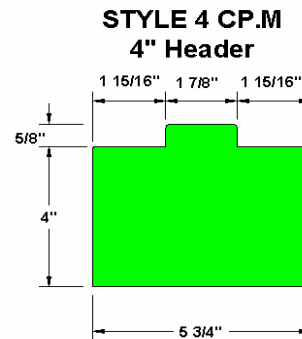
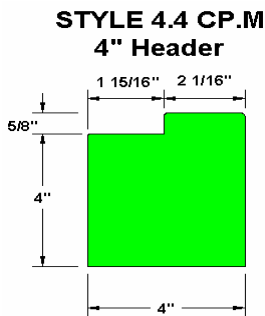
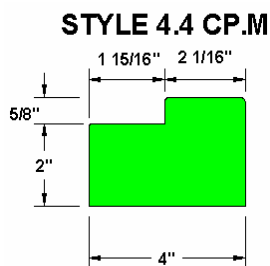
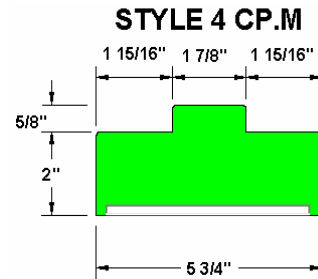
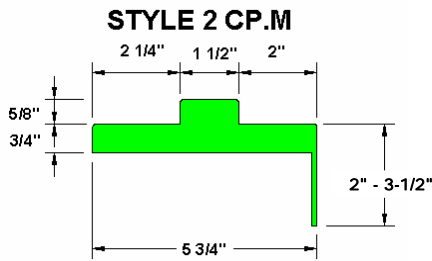
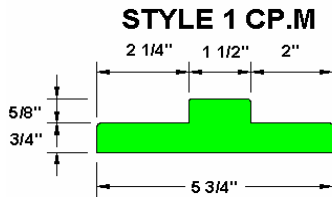

MOLDED IN WINDOW

Seamless design

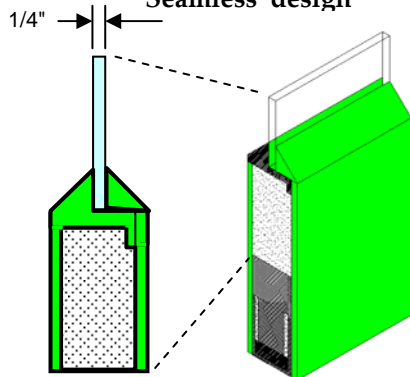

WXL WINDOW

SLIM LINE WINDOW

MOLDED IN WINDOW

Seamless lites available in a variety of sizes

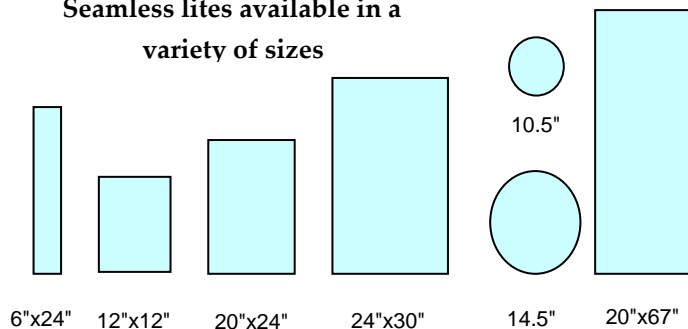

NOTE : ALL TESTS AND CERTIFICATIONS PERFORMED BY INDEPENDENT ACCREDITED LABORATORIES. CONTACT Chem-Pruf® FOR DETAILED MODEL/SERIES VALUES OR GO ONLINE AT WWW.CHEM-PRUF.COM. TESTS RESULTS SHALL BE MADE AVAILABLE UPON REQUEST FOR EACH MODEL LISTED ABOVE. COPYRIGHT CHEM-PRUF DOOR CO. LT. 2010

MODEL CP7 CHEM PRUF NIH DOOR

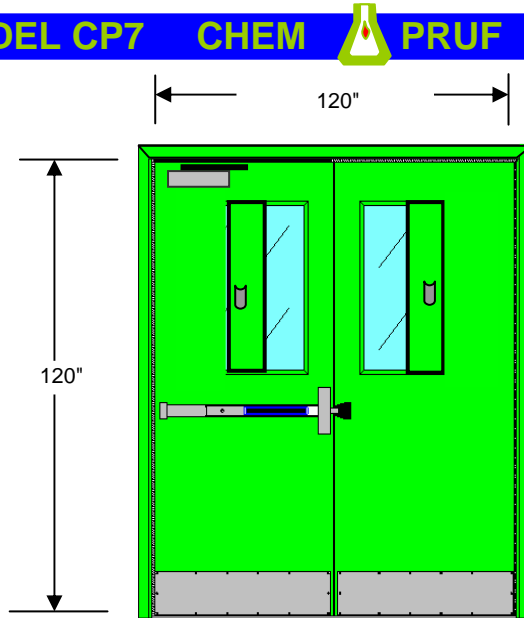

MAXIMUM DOOR SIZE : 58" X 118"

BIO SAFETY LEVEL

FRAME STYLES AVAILABLE

CORE MATERIALS AVAILABLE

STYLE	WIDTH		THERMAL R	SOUND STC
1	3-1/2" TO 5-3/4"	FOAM	11	33
2	3-1/2" TO 5-3/4"	PPC (standard)	3	33
4 optional 4" HDR	5-3/4"	MINERAL CORE	2	35
4.4 optional 4" HDR	4"	BALSA	2	33
11 optional 4" HDR	VARIABLE UP TO 9"			

WINDOW SIZE 6" x 24" WITH OPTIONAL COVER

HARDWARE* *FACTORY INSTALLED - CERTIFIED CRAFTSMEN

Entry Devices

Unlimited

Closers

Unlimited

Hinges

Unlimited

Accessories

Unlimited

Window

Magnetic cover

Special Request

Available

APPLICABLE STANDARDS

AAMA 920-03 CYCLE PERFORMANCE
ASTM C518 HEAT TRANSFER PROPERTIES
ASTM D 1929 SELF IGNITION
ASTM D 2843 SMOKE DENSITY
ASTM D 790 FLEXURAL PROPERTIES
SFBC 3603.2 FORCED ENTRY TEST
ASTM E 84 BURNING CHARACTERISTICS

ANSI A250.4 ENDURANCE OF DOORS
ASTM D 1622 DENSITY & SPECIFIC GRAVITY
ASTM D 256 IZOD IMPACT RESISTANCE
ASTM D 635 RATE OF BURNING
ASTM D 792 DENSITY OF PLASTICS
ASTM E 1886 IMPACT PERFORMANCE
ASTM G 155 LIGHT EXPOSURE

ASTM C 177 THERMAL PROPERTIES
ASTM D 1761 PROPERTIES OF FASTENERS
ASTM D 2583 HARDNESS OF MATERIALS
ASTM D 638 PLASTICS TENSILE STRENGTH
ASTM D 882 TENSILE PROPERTIES
ASTM E 1996 IMPACT OF SYSTEMS
NWWEA TM-7 ENDURANCE OF DOORS

NOTE : ALL TESTS AND CERTIFICATIONS PERFORMED BY INDEPENDENT ACCREDITED LABORATORIES. CONTACT Chem-Pruf® FOR DETAILED MODEL/SERIES VALUES OR GO ONLINE AT WWW.CHEM-PRUF.COM. TESTS RESULTS SHALL BE MADE AVAILABLE UPON REQUEST FOR EACH MODEL LISTED ABOVE. COPYRIGHT CHEM-PRUF DOOR CO. LT. 2010

**** FRAME STYLES & PROFILES**

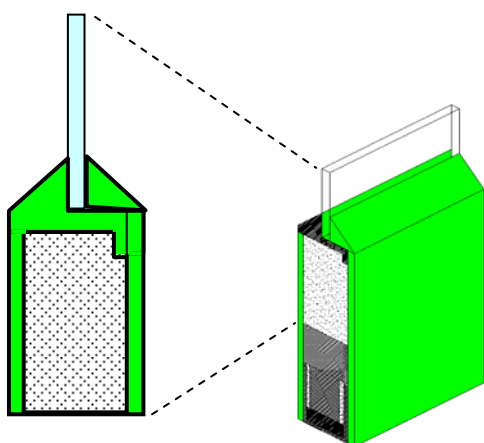
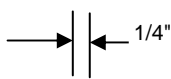
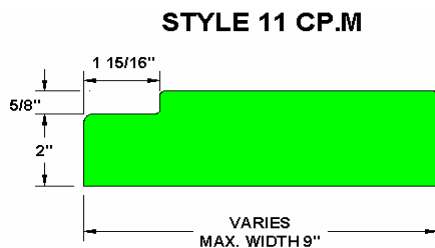
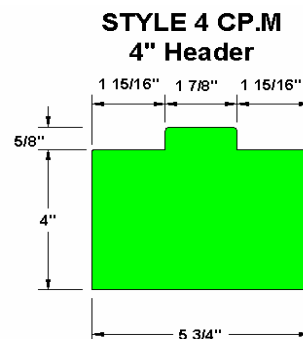
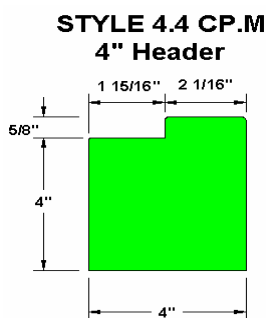
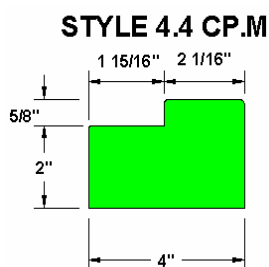
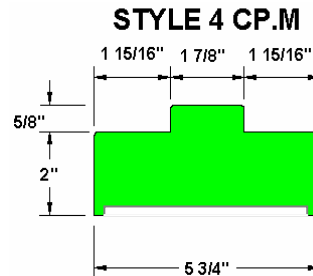
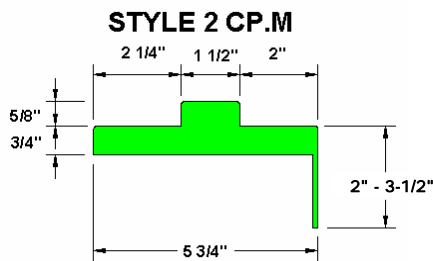
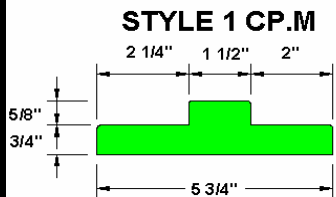

NIH MOLDED IN WINDOW
Seamless design

LITE SIZE
6" x 24"

NIH MAGNETIC
Open / Close cover

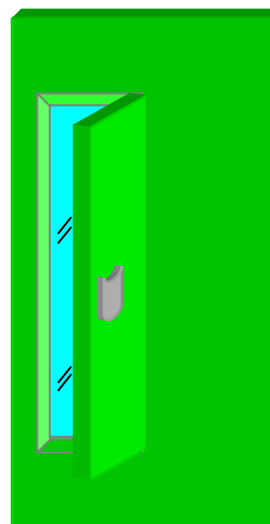

NOTE : ALL TESTS AND CERTIFICATIONS PERFORMED BY INDEPENDENT ACCREDITED LABORATORIES. CONTACT Chem-Pruf® FOR DETAILED MODEL/SERIES VALUES OR GO ONLINE AT WWW.CHEM-PRUF.COM. TESTS RESULTS SHALL BE MADE AVAILABLE UPON REQUEST FOR EACH MODEL LISTED ABOVE. COPYRIGHT CHEM-PRUF DOOR CO. LT. 2010

MODEL CP8 CHEM PRUF PHARMACEUTICAL DOOR

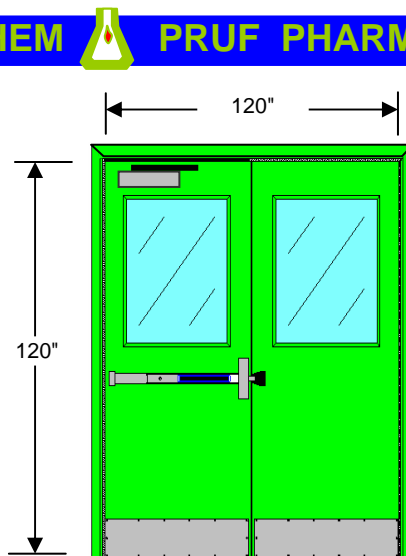

MAXIMUM DOOR LEAF SIZE: 58" X 118"

CERTIFICATION : ATMOSPHERIC PATENTED DOOR

FRAME STYLES AVAILABLE

CORE MATERIALS AVAILABLE

STYLE	WIDTH	THERMAL R	SOUND STC
4	5-3/4"	3	33

WINDOW SIZE

WINDOW STYLE

LITE SIZE	GLASS THK	LITE SIZE	GLASS THK	WINDOW STYLE
24" x 30"	7/16"	6" x 24"	7/16"	Molded in Pharmaceutical Design
20" x 24"	7/16"	12" x 12"	7/16"	

HARDWARE*

*FACTORY INSTALLED CERTIFIED CRAFTSMEN

Entry Devices

Panic Device

Hinges

(3) 4-1/2"

Accessories

Astragal
Kickplate
Threshold Panic Type

Door Bottom
Flush Bolt
Weather Strip

Closers

Yes

APPLICABLE STANDARDS

AAMA 920-03 CYCLE PERFORMANCE
ASTM C518 HEAT TRANSFER PROPERTIES
ASTM D 1929 SELF IGNITION
ASTM D 2843 SMOKE DENSITY
ASTM D 790 FLEXURAL PROPERTIES
ASTM E 330 STRUCTURAL TEST OF DOORS
ASTM E 283 TEST AIR LEAKAGE ON DOORS
NWWEA TM-7 ENDURANCE OF DOORS

ANSI A250.4 ENDURANCE OF DOORS
ASTM D 1622 DENSITY & SPECIFIC GRAVITY
ASTM D 256 IZOD IMPACT RESISTANCE
ASTM D 635 RATE OF BURNING
ASTM D 792 DENSITY OF PLASTICS
ASTM E 1886 IMPACT PERFORMANCE
ASTM G 155 LIGHT EXPOSURE
SFBC PA 201 IMPACT OF LARGE MISSILES

ASTM C 177 THERMAL PROPERTIES
ASTM D 1761 PROPERTIES OF FASTENERS
ASTM D 2583 HARDNESS OF MATERIALS
ASTM D 638 PLASTICS TENSILE STRENGTH
ASTM D 882 TENSILE PROPERTIES
ASTM E 1996 IMPACT OF SYSTEMS
ASTM E 84 BURNING CHARACTERISTICS

NOTE : ALL TESTS AND CERTIFICATIONS PERFORMED BY INDEPENDENT ACCREDITED LABORATORIES. CONTACT Chem-Pruf® FOR DETAILED MODEL/SERIES VALUES OR GO ONLINE AT WWW.CHEM-PRUF.COM. TESTS RESULTS SHALL BE MADE AVAILABLE UPON REQUEST FOR EACH MODEL LISTED ABOVE. COPYRIGHT CHEM-PRUF DOOR CO. LT. 2010

**** FRAME STYLES & PROFILES**

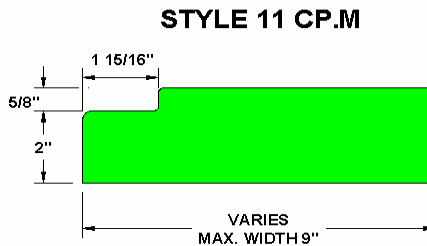
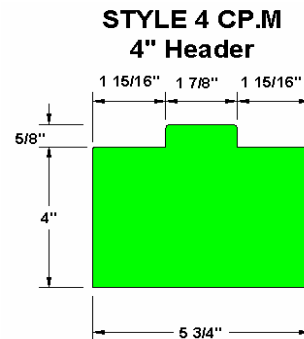
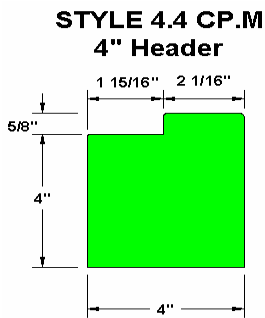
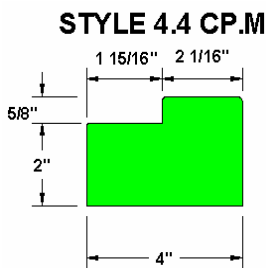
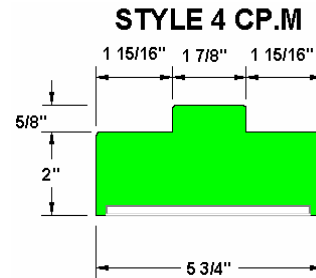
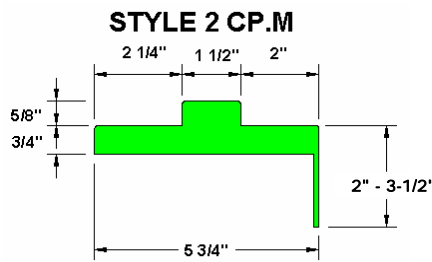
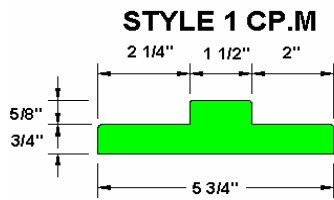

MOLDED IN WINDOW
Seamless design

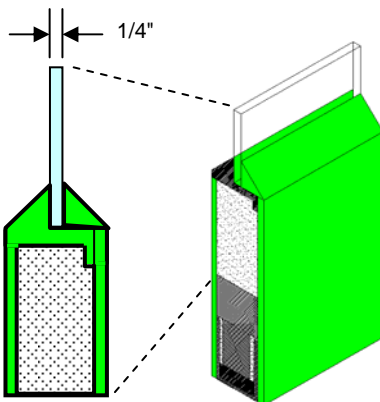

**** WINDOW PROFILE**

MOLDED IN WINDOW
Seamless lites available in a variety of sizes

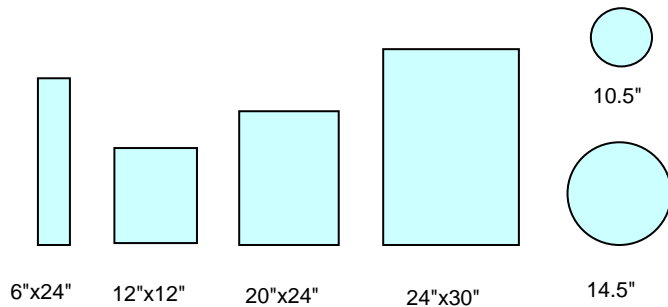

NOTE : ALL TESTS AND CERTIFICATIONS PERFORMED BY INDEPENDENT ACCREDITED LABORATORIES. CONTACT Chem-Pruf® FOR DETAILED MODEL/SERIES VALUES OR GO ONLINE AT WWW.CHEM-PRUF.COM. TESTS RESULTS SHALL BE MADE AVAILABLE UPON REQUEST FOR EACH MODEL LISTED ABOVE. COPYRIGHT CHEM-PRUF DOOR CO. LT. 2010

MODEL CP9 CHEM PRUF HURRICANE DOOR

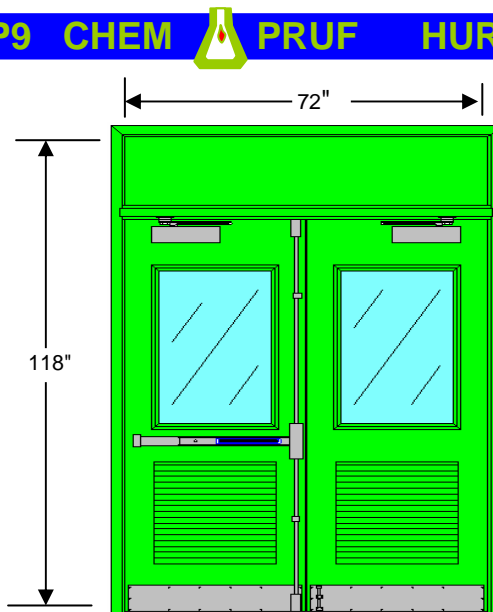

MAXIMUM DOOR LEAF SIZE : 35-3/4" X 93-1/8"

CERTIFICATION : FBC +/- 55 PSF FL # 13087

FRAME STYLES AVAILABLE

CORE MATERIALS AVAILABLE

STYLE	WIDTH	THERMAL R	SOUND STC
4	5-3/4"	PPC	2.85

HARDWARE*

HURRICANE RATED *FACTORY INSTALLED CERTIFIED CRAFTSMEN

Entry Devices

Panic Device

Hinges

(8) 4-1/2"

Closer

Yes

Window

Up to 792 sq.in. x 9/16" thk

Louver

24" X 24"

Louver Cover

26" x 26"

Transom

71-3/4" x 21-1/2"

Accessories

Astragal

Kickplate

Automatic Door Bottom

Threshold Panic Type

Weather Strip

Surface Bolt

Flush Bolt

APPLICABLE STANDARDS

ASTM C518 HEAT TRANSFER PROPERTIES
 ASTM D 1929 SELF IGNITION
 ASTM D 2843 SMOKE DENSITY
 ASTM D 790 FLEXURAL PROPERTIES
 ASTM E 330 STRUCTURAL TEST OF DOORS
 ASTM E 283 TEST AIR LEAKAGE ON DOORS
 SFBC 3603.2 FORCED ENTRY TEST
 SFBC PA 202 STATIC LOAD OF DOORS

ASTM D 1622 DENSITY & SPECIFIC GRAVITY
 ASTM D 256 IZOD IMPACT RESISTANCE
 ASTM D 635 RATE OF BURNING
 ASTM D 792 DENSITY OF PLASTICS
 ASTM E 1886 IMPACT PERFORMANCE
 ASTM G 155 LIGHT EXPOSURE
 SFBC PA 201 IMPACT OF LARGE MISSILES
 SFBC PA 203 CYCLIC WIND PRESSURE

ASTM C 177 THERMAL PROPERTIES
 ASTM D 1761 PROPERTIES OF FASTENERS
 ASTM D 2583 HARDNESS OF MATERIALS
 ASTM D 638 PLASTICS TENSILE STRENGTH
 ASTM D 882 TENSILE PROPERTIES
 ASTM E 1996 IMPACT OF SYSTEMS
 ASTM E 84 BURNING CHARACTERISTICS

NOTE : ALL TESTS AND CERTIFICATIONS PERFORMED BY INDEPENDENT ACCREDITED LABORATORIES. CONTACT Chem-Pruf® FOR DETAILED MODEL/SERIES VALUES OR GO ONLINE AT WWW.CHEM-PRUF.COM. TESTS RESULTS SHALL BE MADE AVAILABLE UPON REQUEST FOR EACH MODEL LISTED ABOVE. COPYRIGHT CHEM-PRUF DOOR CO. LT. 2010

**** FRAME STYLES & PROFILES**

STYLE 4 CP.M

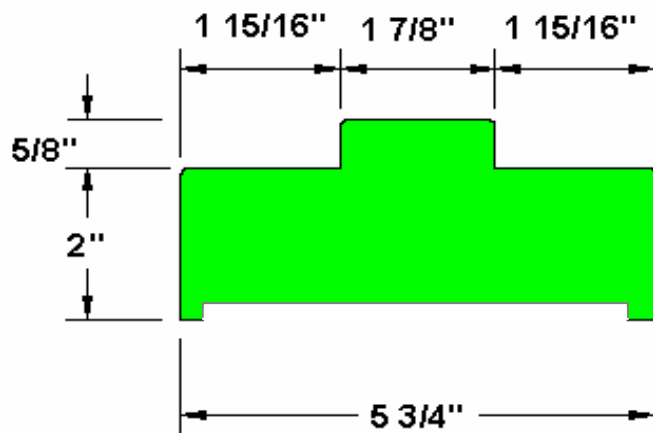

WXL WINDOW PROFILE

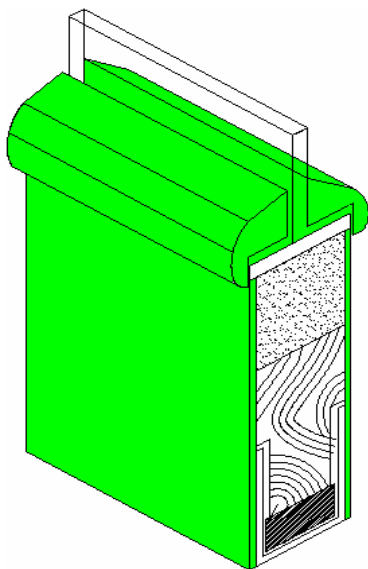

INVERTED "V" LOUVER & COVER PROFILE

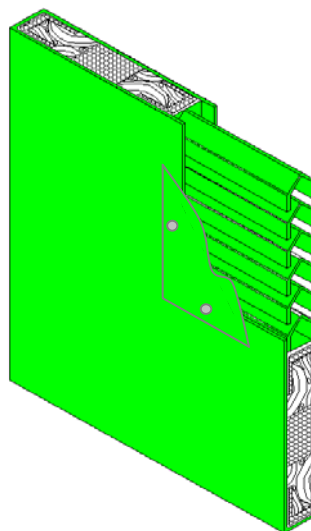

NOTE : ALL TESTS AND CERTIFICATIONS PERFORMED BY INDEPENDENT ACCREDITED LABORATORIES. CONTACT Chem-Pruf® FOR DETAILED MODEL/SERIES VALUES OR GO ONLINE AT WWW.CHEM-PRUF.COM. TESTS RESULTS SHALL BE MADE AVAILABLE UPON REQUEST FOR EACH MODEL LISTED ABOVE. COPYRIGHT CHEM-PRUF DOOR CO. LT. 2010

MODEL CP10 CHEM PRUF MOLDED LITE STORM FBC CERTIFIED DOOR

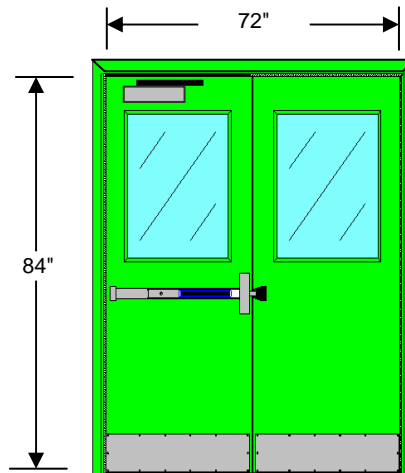

MAXIMUM DOOR LEAF SIZE: 36" X 84"

CERTIFICATION : FBC +/- 50 PSF

FRAME STYLES AVAILABLE

STYLE	WIDTH
4	5-3/4"

CORE MATERIALS AVAILABLE

PPC	THERMAL R	SOUND STC
	3	33

WINDOW SIZE

LITE SIZE	GLASS THK	LITE SIZE	GLASS THK
24" x 30"	7/16"	6" x 24"	7/16"
20" x 24"	7/16"	12" x 12"	7/16"

WINDOW STYLE

Molded in Pharmaceutical Design

HARDWARE*

HURRICANE RATED *FACTORY INSTALLED CERTIFIED CRAFTSMEN

Entry Devices

Panic Device

Hinges

(3) 4-1/2"

Accessories

Astragal	Door Bottom
Kickplate	Flush Bolt
Threshold Panic Type	Weather Strip

Closers

Yes

APPLICABLE STANDARDS

AAMA 920-03 CYCLE PERFORMANCE
ASTM C518 HEAT TRANSFER PROPERTIES
ASTM D 1929 SELF IGNITION
ASTM D 2843 SMOKE DENSITY
ASTM D 790 FLEXURAL PROPERTIES
ASTM E 330 STRUCTURAL TEST OF DOORS
ASTM E 283 TEST AIR LEAKAGE ON DOORS
SFBC 3603.2 FORCED ENTRY TEST
SFBC PA 203 CYCLIC WIND PRESSURE

ANSI A250.4 ENDURANCE OF DOORS
ASTM D 1622 DENSITY & SPECIFIC GRAVITY
ASTM D 256 IZOD IMPACT RESISTANCE
ASTM D 635 RATE OF BURNING
ASTM D 792 DENSITY OF PLASTICS
ASTM E 1886 IMPACT PERFORMANCE
ASTM G 155 LIGHT EXPOSURE
SFBC PA 201 IMPACT OF LARGE MISSILES
NIJ NIFPA TM-7 ENDURANCE OF DOORS

ASTM C 177 THERMAL PROPERTIES
ASTM D 1761 PROPERTIES OF FASTENERS
ASTM D 2583 HARDNESS OF MATERIALS
ASTM D 638 PLASTICS TENSILE STRENGTH
ASTM D 882 TENSILE PROPERTIES
ASTM E 1996 IMPACT OF SYSTEMS
ASTM E 84 BURNING CHARACTERISTICS
SFBC PA 202 STATIC LOAD ON DOOR SYS.

NOTE : ALL TESTS AND CERTIFICATIONS PERFORMED BY INDEPENDENT ACCREDITED LABORATORIES. CONTACT Chem-Pruf® FOR DETAILED MODEL/SERIES VALUES OR GO ONLINE AT WWW.CHEM-PRUF.COM. TESTS RESULTS SHALL BE MADE AVAILABLE UPON REQUEST FOR EACH MODEL LISTED ABOVE. COPYRIGHT CHEM-PRUF DOOR CO. LT. 2010

**MODEL CP10 CHEM PRUF MOLDED LITE STORM
FBC CERTIFIED DOOR**

**** FRAME STYLES & PROFILES**

STYLE 4 CP.M

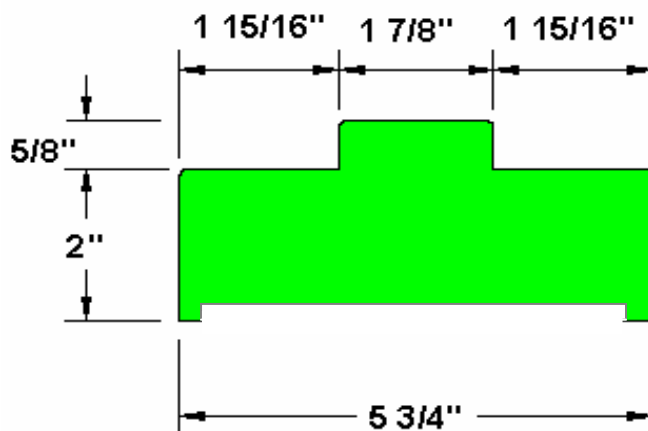

MOLDED IN WINDOW
Seamless design

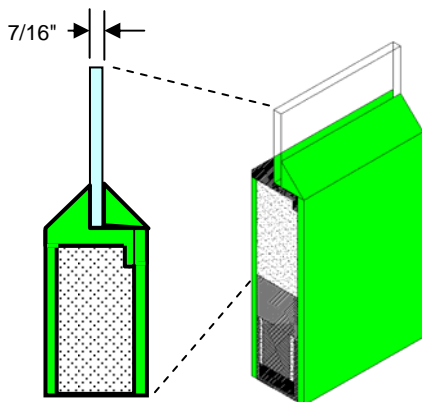

MOLDED IN WINDOW

Seamless lites available in a variety of sizes

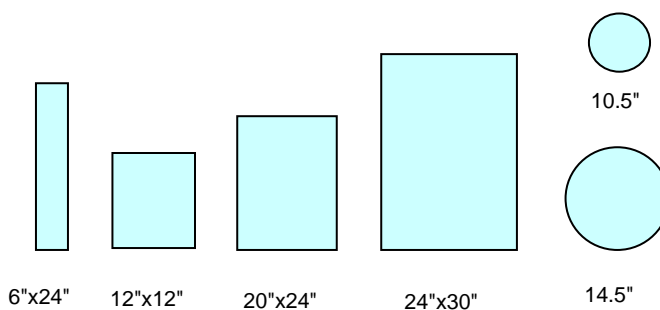

NOTE : ALL TESTS AND CERTIFICATIONS PERFORMED BY INDEPENDENT ACCREDITED LABORATORIES. CONTACT Chem-Pruf® FOR DETAILED MODEL/SERIES VALUES OR GO ONLINE AT WWW.CHEM-PRUF.COM. TESTS RESULTS SHALL BE MADE AVAILABLE UPON REQUEST FOR EACH MODEL LISTED ABOVE. COPYRIGHT CHEM-PRUF DOOR CO. LT. 2010

MODEL CP11 CHEM PRUF FULL LOUVER DOUBLE DOOR

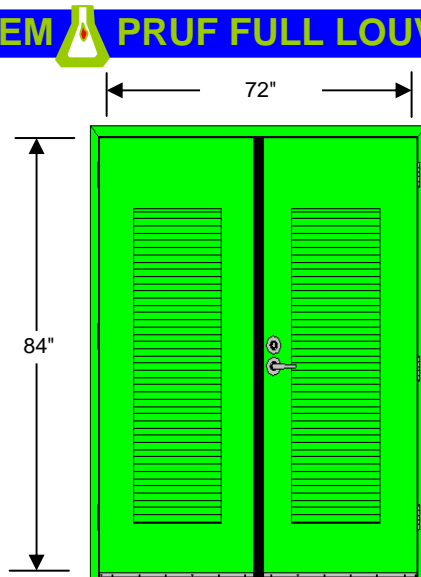

MAXIMUM DOOR LEAF SIZE : 36" X 84"

CERTIFICATION : FBC +/-70 PSF

FRAME STYLES AVAILABLE

CORE MATERIALS AVAILABLE

STYLE	WIDTH	THERMAL R	SOUND STC
4	5-3/4"	PPC	2.85

HARDWARE* HURRICANE RATED *FACTORY INSTALLED CERTIFIED CRAFTSMEN

Entry Devices

Cylindrical / Dead bolt

Interconnected

Accessories

Astragal

Kickplate

Threshold Panic Type

Weather Strip

Flush Bolt

Hinges

(6) 4-1/2"

Closers

Yes

Louver

22" X 60"

Louver Cover : 24" x 62"

APPLICABLE STANDARDS

AAMA 920-03 CYCLE PERFORMANCE
ASTM C518 HEAT TRANSFER PROPERTIES
ASTM D 1929 SELF IGNITION
ASTM D 2843 SMOKE DENSITY
ASTM D 790 FLEXURAL PROPERTIES
ASTM E 330 STRUCTURAL TEST OF DOORS
ASTM E 283 TEST AIR LEAKAGE ON DOORS
SFBC 3603.2 FORCED ENTRY TEST
SFBC PA 203 CYCLIC WING PRESSURE

ANSI A250.4 ENDURANCE OF DOORS
ASTM D 1622 DENSITY & SPECIFIC GRAVITY
ASTM D 256 IZOD IMPACT RESISTANCE
ASTM D 635 RATE OF BURNING
ASTM D 792 DENSITY OF PLASTICS
ASTM E 1886 IMPACT PERFORMANCE
ASTM G 155 LIGHT EXPOSURE
SFBC PA 201 IMPACT OF LARGE MISSILES
NWWEA TM-7 ENDURANCE OF DOORS

ASTM C 177 THERMAL PROPERTIES
ASTM D 1761 PROPERTIES OF FASTENERS
ASTM D 2583 HARDNESS OF MATERIALS
ASTM D 638 PLASTICS TENSILE STRENGTH
ASTM D 882 TENSILE PROPERTIES
ASTM E 1996 IMPACT OF SYSTEMS
ASTM E 84 BURNING CHARACTERISTICS
SFBC PA 202 STATIC LOAD ON DOOR SYS.

NOTE : ALL TESTS AND CERTIFICATIONS PERFORMED BY INDEPENDENT ACCREDITED LABORATORIES. CONTACT Chem-Pruf® FOR DETAILED MODEL/SERIES VALUES OR GO ONLINE AT WWW.CHEM-PRUF.COM. TESTS RESULTS SHALL BE MADE AVAILABLE UPON REQUEST FOR EACH MODEL LISTED ABOVE. COPYRIGHT CHEM-PRUF DOOR CO. LT. 2010

**** FRAME STYLES & PROFILES**

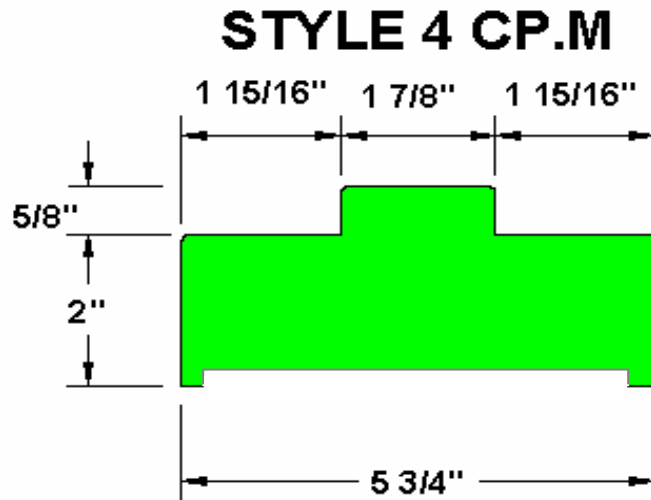

**** INVERTED "V" LOUVER & LOUVER COVER DETAIL**

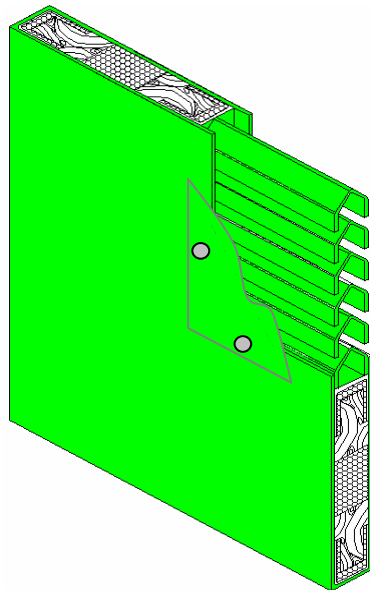

NOTE : ALL TESTS AND CERTIFICATIONS PERFORMED BY INDEPENDENT ACCREDITED LABORATORIES. CONTACT Chem-Pruf® FOR DETAILED MODEL/SERIES VALUES OR GO ONLINE AT WWW.CHEM-PRUF.COM. TESTS RESULTS SHALL BE MADE AVAILABLE UPON REQUEST FOR EACH MODEL LISTED ABOVE. COPYRIGHT CHEM-PRUF DOOR CO. LT. 2010

MODEL CP12 CHEM PRUF HURRICANE DOOR

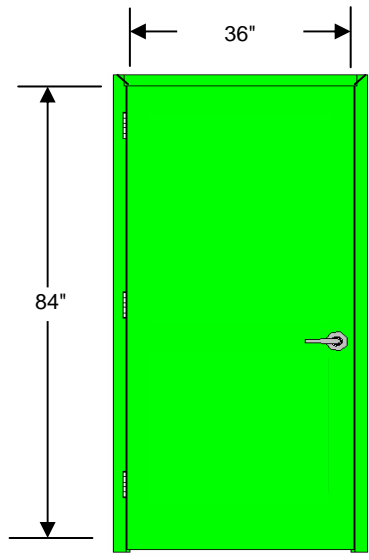

MAXIMUM DOOR LEAF SIZE : 36" X 84"

CERTIFICATION : TDI / FBC + / - 70 PSF FL # 205

FRAME STYLES AVAILABLE		CORE MATERIALS AVAILABLE		
STYLE	WIDTH		THERMAL R	SOUND STC
4	5-3/4"	PPC	3	33

HARDWARE* HURRICANE RATED *FACTORY INSTALLED CERTIFIED CRAFTSMEN

Entry Devices	Closers	Hinges	Accessories
Mortise Cylindrical	Yes	(3) 4-1/2"	Weather Strip Threshold Panic Type

APPLICABLE STANDARDS

AAMA 920-03 CYCLE PERFORMANCE ASTM C518 HEAT TRANSFER PROPERTIES ASTM D 1929 SELF IGNITION ASTM D 2843 SMOKE DENSITY ASTM D 790 FLEXURAL PROPERTIES ASTM E 1332 SOUND TRANSMISSION ASTM E 2235 SOUND INSULATIONS ASTM E 90 SOUND LOSS SFBC 3603.2 FORCED ENTRY TEST TDI TEXAS DEPARTMENT OF INSURANCE	ANSI A250.4 ENDURANCE OF DOORS ASTM D 1622 DENSITY & SPECIFIC GRAVITY ASTM D 256 IZOD IMPACT RESISTANCE ASTM D 635 RATE OF BURNING ASTM D 792 DENSITY OF PLASTICS ASTM E 1886 IMPACT PERFORMANCE ASTM E 413 RATING OF SOUND INSULATION ASTM G 155 LIGHT EXPOSURE ASTM E 330 STRUCTURAL TEST OF DOORS	ASTM C 177 THERMAL PROPERTIES ASTM D 1761 PROPERTIES OF FASTENERS ASTM D 2583 HARDNESS OF MATERIALS ASTM D 638 PLASTICS TENSILE STRENGTH ASTM D 882 TENSILE PROPERTIES ASTM E 1996 IMPACT OF SYSTEMS ASTM E 84 BURNING CHARACTERISTICS NWWEA TM-7 ENDURANCE OF DOORS
--	---	---

NOTE : ALL TESTS AND CERTIFICATIONS PERFORMED BY INDEPENDENT ACCREDITED LABORATORIES. CONTACT Chem-Pruf® FOR DETAILED MODEL/SERIES VALUES OR GO ONLINE AT WWW.CHEM-PRUF.COM. TESTS RESULTS SHALL BE MADE AVAILABLE UPON REQUEST FOR EACH MODEL LISTED ABOVE. COPYRIGHT CHEM-PRUF DOOR CO. LT. 2010

**** FRAME STYLES & PROFILES**

STYLE 4 CP.M

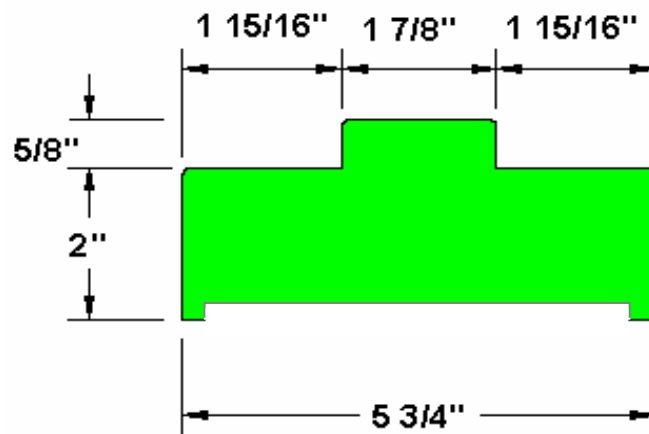

NOTE : ALL TESTS AND CERTIFICATIONS PERFORMED BY INDEPENDENT ACCREDITED LABORATORIES. CONTACT Chem-Pruf® FOR DETAILED MODEL/SERIES VALUES OR GO ONLINE AT WWW.CHEM-PRUF.COM. TESTS RESULTS SHALL BE MADE AVAILABLE UPON REQUEST FOR EACH MODEL LISTED ABOVE. COPYRIGHT CHEM-PRUF DOOR CO. LT. 2010

MODEL CP13 CHEM PRUF FEMA DOOR

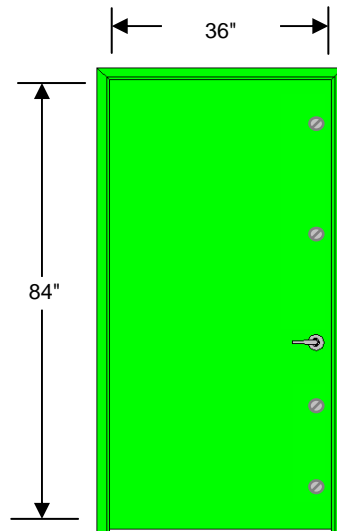

MAXIMUM DOOR SIZE: 36" x 84"

CERTIFICATION : FEMA 320

FRAME STYLES AVAILABLE

CORE MATERIALS AVAILABLE

STYLE	WIDTH	THERMAL R	SOUND STC
4	5-3/4"	2	42

FRP GLASS PLATE
(DOOR & FRAME)

HARDWARE*

*FACTORY INSTALLERS - CERTIFIED CRAFTSMEN

Entry Devices

Passage lock

Deadbolt (4)

Dead bolt Maxum BX SR OPC-FN

Hinges (6)

Full Mortise 6" X 5"

APPLICABLE STANDARDS

FEMA 320 TEST OF TORNADO DOOR SHELTER
ICC 500 DESIGN OF STORM SHELTERS
ASTM C 177 THERMAL PROPERTIES
ASTM C 518 HEAT TRANSFER PROPERTIES
ASTM D 1622 DENSITY & SPECIFIC GRAVITY
ASTM D 1761 PROPERTIES OF FASTENERS
ASTM D 1929 SELF IGNITION

ASTM D 638 PLASTICS TENSILE STRENGTH
ASTM D 790 FLEXURAL PROPERTIES
ASTM D 792 DENSITY OF PLASTICS
ASTM D 882 TENSILE PROPERTIES
ASTM E 1332 SOUND TRANSMISSION
ASTM E 2235 SOUND INSULATIONS
ASTM E 413 RATING OF SOUND INSULATION

ASTM E 90 SOUND LOSS
ASTM G 155 LIGHT EXPOSURE
ASTM D 2583 HARDNESS OF MATERIALS
ASTM D 2843 SMOKE DENSITY
ASTM D 635 RATE OF BURNING
ASTM D 256 IZOD IMPACT RESISTANCE
ASTM E 84 BURNING CHARACTERISTICS

NOTE : ALL TESTS AND CERTIFICATIONS PERFORMED BY INDEPENDENT ACCREDITED LABORATORIES. CONTACT Chem-Pruf® FOR DETAILED MODEL/SERIES VALUES OR GO ONLINE AT WWW.CHEM-PRUF.COM. TESTS RESULTS SHALL BE MADE AVAILABLE UPON REQUEST FOR EACH MODEL LISTED ABOVE. COPYRIGHT CHEM-PRUF DOOR CO. LT. 2010

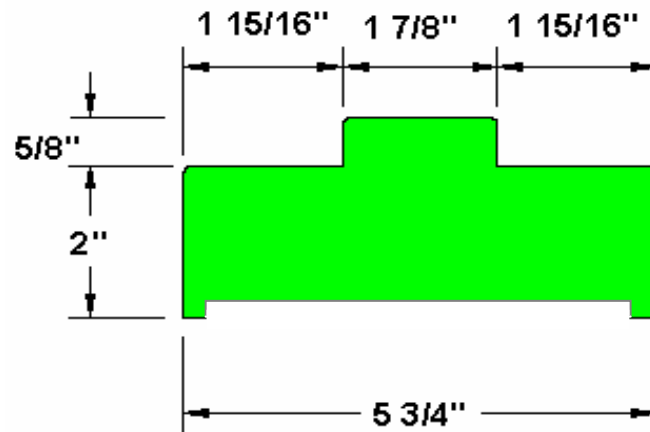
**** FRAME STYLES & PROFILES****STYLE 4 CP.M**

NOTE : ALL TESTS AND CERTIFICATIONS PERFORMED BY INDEPENDENT ACCREDITED LABORATORIES. CONTACT Chem-Pruf® FOR DETAILED MODEL/SERIES VALUES OR GO ONLINE AT WWW.CHEM-PRUF.COM. TESTS RESULTS SHALL BE MADE AVAILABLE UPON REQUEST FOR EACH MODEL LISTED ABOVE. COPYRIGHT CHEM-PRUF DOOR CO. LT. 2010

MODEL CP14 CHEM PRUF FIRE RATED 4080 DOOR FBC CERTIFIED DOOR

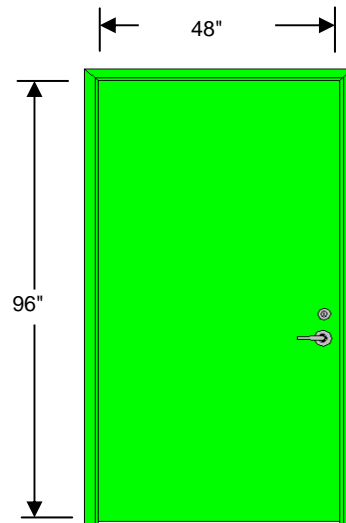

MAXIMUM DOOR SIZE : 48" X 96"

CERTIFICATION : UL 10(b) & UL 10(c) FBC +/- 40 PSF FL # 12140 / TDI

FRAME STYLES AVAILABLE		CORE MATERIALS AVAILABLE		
STYLE	WIDTH		THERMAL R	SOUND STC
4	5-3/4"	MINERAL CORE	2	35

HARDWARE* HURRICANE AND FIRE RATED *FACTORY INSTALLED CERTIFIED CRAFTSMEN

Entry Devices

Mortise Type

Hinges

(4) 4-1/2"

Accessories

Threshold Panic Type
Weather Strip Fire rated

APPLICABLE STANDARDS

<ul style="list-style-type: none"> UL 10C FIRE TESTS OF DOOR ASSEMBLIES UL 10B FIRE TESTS OF DOOR ASSEMBLIES NFPA 252 FIRE TESTS OF DOORS NFPA 80 FIRE TESTS OF DOORS SFBC PA 201 LARGE MISSILE IMPACT SFBC PA 202 STATIC LOAD TEST SFBC PA 203 CYCLIC WIND TEST SFBC 3603.2 FORCED ENTRY TEST ASTM E 1886 TEST OF EXTERIOR SYSTEMS ASTM E 1996 IMPACT OF EXTERIOR SYST. ASTM E 330 STRUCTURAL TEST OF DOORS TDI TEXAS DEPARTMENT OF INSURANCE 	<ul style="list-style-type: none"> ASTM D 638 PLASTICS TENSILE STRENGTH ASTM D 790 FLEXURAL PROPERTIES ASTM D 792 DENSITY OF PLASTICS ASTM D 882 TENSILE PROPERTIES ASTM E 1332 SOUND TRANSMISSION ASTM E 152 FIRE TESTS OF DOOR ASSEMBLIES ASTM E 2235 SOUND INSULATIONS ASTM E 413 RATING OF SOUND INSULATION ASTM E 84 BURNING CHARACTERISTICS ASTM E 90 SOUND LOSS ASTM E 2074 FIRE TEST OF DOORS 	<ul style="list-style-type: none"> ASTM C 177 THERMAL PROPERTIES ASTM C 518 HEAT TRANSFER PROPERTIES ASTM D 1622 DENSITY & SPECIFIC GRAVITY ASTM D 1761 PROPERTIES OF FASTENERS ASTM D 1929 SELF IGNITION ASTM D 256 IZOD IMPACT RESISTANCE ASTM D 2583 HARDNESS OF MATERIALS ASTM D 2843 SMOKE DENSITY ASTM D 635 RATE OF BURNING ASTM G 155 LIGHT EXPOSURE ASTM E 283 AIR LEAKAGE TESTS
--	--	--

NOTE : ALL TESTS AND CERTIFICATIONS PERFORMED BY INDEPENDENT ACCREDITED LABORATORIES. CONTACT Chem-Pruf® FOR DETAILED MODEL/SERIES VALUES OR GO ONLINE AT WWW.CHEM-PRUF.COM. TESTS RESULTS SHALL BE MADE AVAILABLE UPON REQUEST FOR EACH MODEL LISTED ABOVE. COPYRIGHT CHEM-PRUF DOOR CO. LT. 2010

**MODEL CP14 CHEM  PRUF FIRE RATED 4080 DOOR
FBC CERTIFIED DOOR**

**** FRAME STYLES & PROFILES**

STYLE 4 CP.M

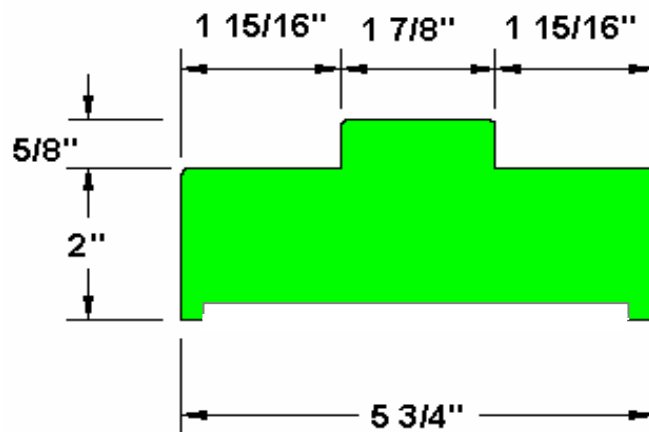

NOTE : ALL TESTS AND CERTIFICATIONS PERFORMED BY INDEPENDENT ACCREDITED LABORATORIES. CONTACT Chem-Pruf® FOR DETAILED MODEL/SERIES VALUES OR GO ONLINE AT WWW.CHEM-PRUF.COM. TESTS RESULTS SHALL BE MADE AVAILABLE UPON REQUEST FOR EACH MODEL LISTED ABOVE. COPYRIGHT CHEM-PRUF DOOR CO. LT. 2010

**MODEL CP15 CHEM PRUF FIRE RATED 3070 DOOR
FBC CERTIFIED DOOR**

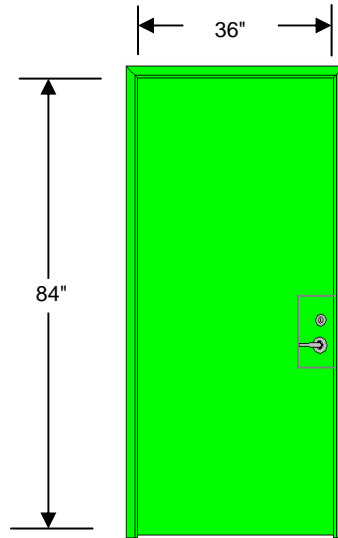

MAXIMUM DOOR SIZE : 36" X 84"

CERTIFICATION : UL 10(b) UL 10(c) FBC +/- 75 PSF FL # 13262

FRAME STYLES AVAILABLE

CORE MATERIALS AVAILABLE

STYLE	WIDTH	THERMAL R	SOUND STC
1	5-3/4"	2	35

HARDWARE*

HURRICANE AND FIRE RATED

*FACTORY INSTALLED CERTIFIED CRAFTSMEN

Entry Devices

Cylindrical Interconnected

Hinges

(3) 4-1/2"

Accessories

Wrap - Around
Weather Strip
Threshold Panic Type

APPLICABLE STANDARDS

UL 10C FIRE TESTS OF DOOR ASSEMBLIES
UL 10B FIRE TESTS OF DOOR ASSEMBLIES
NFPA 252 FIRE TESTS OF DOORS
NFPA 80 FIRE TESTS OF DOORS
SFBC PA 201 LARGE MISSILE IMPACT
SFBC PA 202 STATIC LOAD TEST
SFBC PA 203 CYCLIC WIND TEST
SFBC 3603.2 FORCED ENTRY TEST
ASTM E 1886 TEST OF EXTERIOR SYSTEMS
ASTM E 1996 IMPACT OF EXTERIOR SYST.
ASTM E 330 STRUCTURAL TEST OF DOORS

ASTM D 638 PLASTICS TENSILE STRENGTH
ASTM D 790 FLEXURAL PROPERTIES
ASTM D 792 DENSITY OF PLASTICS
ASTM D 882 TENSILE PROPERTIES
ASTM E 1332 SOUND TRANSMISSION
ASTM E 152 FIRE TESTS OF DOOR ASSEMBLIES
ASTM E 2235 SOUND INSULATIONS
ASTM E 413 RATING OF SOUND INSULATION
ASTM E 84 BURNING CHARACTERISTICS
ASTM E 90 SOUND LOSS
ASTM E 2074 FIRE TEST OF DOORS

ASTM C 177 THERMAL PROPERTIES
ASTM C 518 HEAT TRANSFER PROPERTIES
ASTM D 1622 DENSITY & SPECIFIC GRAVITY
ASTM D 1761 PROPERTIES OF FASTENERS
ASTM D 1929 SELF IGNITION
ASTM D 256 IZOD IMPACT RESISTANCE
ASTM D 2583 HARDNESS OF MATERIALS
ASTM D 2843 SMOKE DENSITY
ASTM D 635 RATE OF BURNING
ASTM G 155 LIGHT EXPOSURE
ASTM E 283 AIR LEAKAGE TESTS

NOTE : ALL TESTS AND CERTIFICATIONS PERFORMED BY INDEPENDENT ACCREDITED LABORATORIES. CONTACT Chem-Pruf® FOR DETAILED MODEL/SERIES VALUES OR GO ONLINE AT WWW.CHEM-PRUF.COM. TESTS RESULTS SHALL BE MADE AVAILABLE UPON REQUEST FOR EACH MODEL LISTED ABOVE. COPYRIGHT CHEM-PRUF DOOR CO. LT. 2010

**MODEL CP15 CHEM  PRUF FIRE RATED 3070 DOOR
FBC CERTIFIED DOOR**

FRAME STYLES & PROFILES

STYLE 1 CP.M

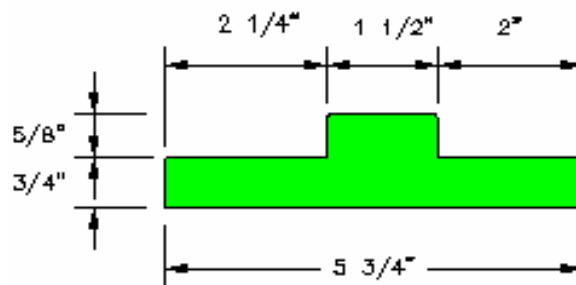

NOTE : ALL TESTS AND CERTIFICATIONS PERFORMED BY INDEPENDENT ACCREDITED LABORATORIES. CONTACT Chem-Pruf® FOR DETAILED MODEL/SERIES VALUES OR GO ONLINE AT WWW.CHEM-PRUF.COM. TESTS RESULTS SHALL BE MADE AVAILABLE UPON REQUEST FOR EACH MODEL LISTED ABOVE. COPYRIGHT CHEM-PRUF DOOR CO. LT. 2010